

# AXCEN

PHOTONICS CORPORATION

## **AXXE-3386 10Gbps Single Mode 1310nm DFB, SFP+ Transceiver**



### **Product Overview**

The AXXE-3386 is specifically designed for the high performance integrated duplex data link over single mode optical fiber. This transceiver module is compliant with the Small Form-factor Pluggable Plus (SFP+) Multi-Source Agreement (SFF-8432). An enhanced Digital Diagnostic Monitoring Interface has been incorporated into the Axcen SFP Transceiver. Real time monitors of temperature, supply voltage, laser bias current, laser average output power and received output power are provided, based on the SFF-8472.

The AXXE-3386 SFP+ transceivers using a 1310nm long wavelength DFB-LD enable data transmission up to 10km on a single mode optical fiber.

### **Features**

- **SFP+ Multi-Source Agreement**
- **LC duplex receptacle**
- **Up to 10km on 9/125µm SMF**
- **10Gbps IEEE 802.3ae 10GBASE-LR and 10GBASE-LW compliant**
- **SFF-8472 diagnostic monitoring interface for optical transceivers**
- **Alarms and warnings to indicate status of real time monitors**
- **Soft TX\_Disable control and monitoring implemented**
- **Soft TX\_FAULT monitoring implemented**
- **Soft RX\_LOS monitoring implemented**
- **Low power consumption**
- **Class 1 laser safety standard IEC 60825 compliant**

### **Applications**

- **8.5G Fibre Channel**
- **10 Gigabit Ethernet**

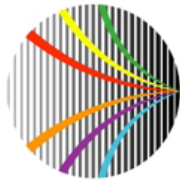

## Block diagram

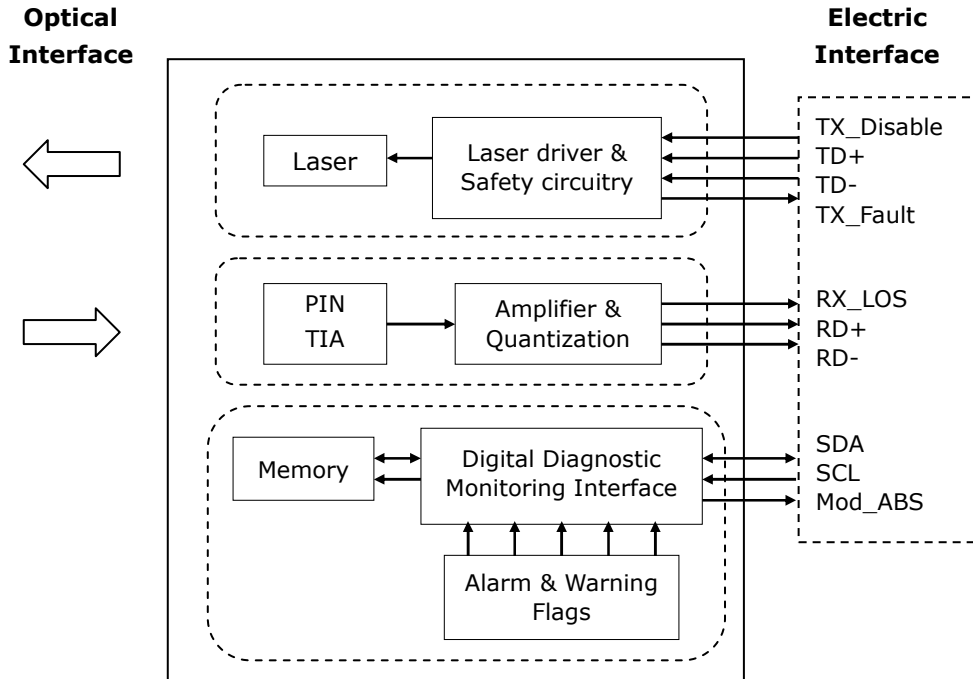

The transceiver is fundamentally consisted by two parts: transmitter and receiver. The transmitter features a TTL logic level Disable signal and a Fault indicator. The receiver features a TTL logic Loss of Signal (RX\_LOS) detection. The serial ID interface defines a 256-byte memory map in Memory, accessible over a 2 wire, serial interface at the 8 bit address 1010000X (A0h). The Digital Diagnostic Monitoring Interface makes use of the 8 bit address 1010001X (A2h), so the originally defined serial ID memory map remains unchanged and is therefore backward compatible. The detailed signal descriptions are listed in the following sections.

## Absolute Maximum Ratings

Parameter	Symbol	Min.	Max.	Unit	Note
Storage Temperature	$T_s$	-40	+85	°C	
Supply Voltage	$V_{ccT}$ $V_{ccR}$	-0.5	4.5	V	
Storage Relative Humidity	RH	5	95	%	
Optical Receiver Input Average Power			+1.5	dBm	

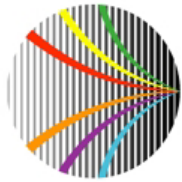

## Recommended Operating Conditions

Parameter	Symbol	Min.	Typ.	Max.	Unit	Note
Case Operating Temperature	$T_C$	0		70	°C	Refer to ordering information
		-40		85		
Supply Voltage	$V_{CC}$	3.14	3.3	3.46	V	
Supply Current	$I_{TX} + I_{RX}$		180	300	mA	
Transmitter Input Single Ended DC Voltage Tolerance		-0.3		4.0	V	
Receiver Output Single Ended DC Voltage Tolerance		-0.3		4.0	V	

## Transmitter Electro-Optical Interface

Parameter	Symbol	Min.	Typ.	Max.	Unit	Note
Transmitter Differential Input Voltage	TD+/-	180		700	mV(p-p)	
Data Dependent Input Jitter	DDJ			0.1	UI	
Data Input Total Jitter	DTJ			0.28	UI	
TX_Fault - Low	$V_{OL}$	-0.3		0.4	V	
TX_Fault - High	$V_{OH}$	2.0		$V_{CC}$	V	
TX_Disable - Low	$V_{IL}$	-0.3		0.8	V	
TX_Disable - High	$V_{IH}$	2.0		$V_{CC}$	V	
Average Launch Power	$P_O$	-8.2		0.5	dBm	1
Launch Power in OMA	$P_{O\_OMA}$	-5.2			dBm	1
Optical Extinction Ratio	$E_R$	3.5			dB	
Center Wavelength	$\lambda_C$	1260		1355	nm	
Side Mode Suppression Ratio	SMSR	30			dB	
Relative Intensity Noise	$RIN_{12OMA}$			-128	dB/Hz	

### Notes:

1. Coupling into a 9/125 $\mu$ m single mode fiber.

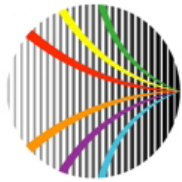

## Receiver Electro-Optical Interface

Parameter	Symbol	Min.	Typ.	Max.	Unit	Note
Receiver Differential Output Voltage	RD +/-	300		1000	mV(p-p)	
Average Receiver Power	P <sub>IN</sub>	-14.4		0.5	dBm	
Receiver Sensitivity in OMA	P <sub>IN_OMA</sub>			-12.6	dBm	1
Operating Center Wavelength	$\lambda_c$	1260		1355	nm	
Receiver Reflectance	RL			-12	dB	
Receiver Loss of Signal De-Assert	P <sub>LOSD</sub>			-17	dBm	
Receiver Loss of Signal Assert	P <sub>LOSA</sub>	-30			dBm	
Receiver Loss of Signal Hysteresis	P <sub>LOSH</sub>	0.5			dB	
Receiver Loss of Signal - Low	V <sub>OL</sub>	-0.3		0.4	V	
Receiver Loss of Signal - High	V <sub>OH</sub>	2.0		V <sub>ccR</sub>	V	

### Notes:

1. With BER better than or equal to  $1 \times 10^{-12}$ , measured in the center of the eye opening with PRBS  $2^{31} - 1$

## Two-Wire Interface

Parameter	Symbol	Min.	Max.	Unit	Note
Host 2-wire Vcc	$V_{CC\_HTWI}$	3.14	3.46		1
SCL and SDA	$V_{OL}$	0.0	0.40	V	2
	$V_{OH}$	$V_{CC\_HTWI}-0.5$	$V_{CC\_HTWI}+0.3$		
SCL and SDA	$V_{IL}$	-0.3	$V_{CC}T*0.3$	V	
	$V_{IH}$	$V_{CC}T*0.7$	$V_{CC}T + 0.5$		
Input current on the SCL and SDA contacts	$I_I$	-10	10	$\mu A$	
Capacitance on SCL and SDA Contacts	$C_i$		14	pF	3
Total bus capacitance for SCL and SDA	$C_b$		100	pF	4
			290		5
Clock Frequency	$f_{SCL}$		400	kHz	
Two-Wire Interface Ready	$t_{serial}$		300	ms	6

### Notes:

1. The Host 2-wire Vcc is the voltage used for resistive pull ups for the 2 wire interface.
2. Rp2w pulled toVcc\_Host\_2w. Rp2w is the pull up resistor. Active bus termination may be used by the host in place of a pullup resistor. Pull ups can be connected to any one of several power supplies, however the host board design shall ensure that no module contact has voltage exceeding module  $V_{CC}T/R + 0.5$  V nor requires the module to sink more than 3.0 mA current.
3. Ci is the capacitance looking into the module SCL and SDA contacts
4. At 400 kHz, 3.0 k $\Omega$  Rp2w, max; At 100 kHz, 8.0 k $\Omega$  Rp2w, max
5. At 400 kHz, 1.1 k $\Omega$  Rp2w, max; At 100 kHz, 2.75 k $\Omega$  Rp2w, max
6. Time from power on until module is ready for data transmission over the two-wire interface.

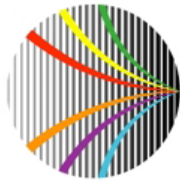

## Digital Diagnostic Memory Map

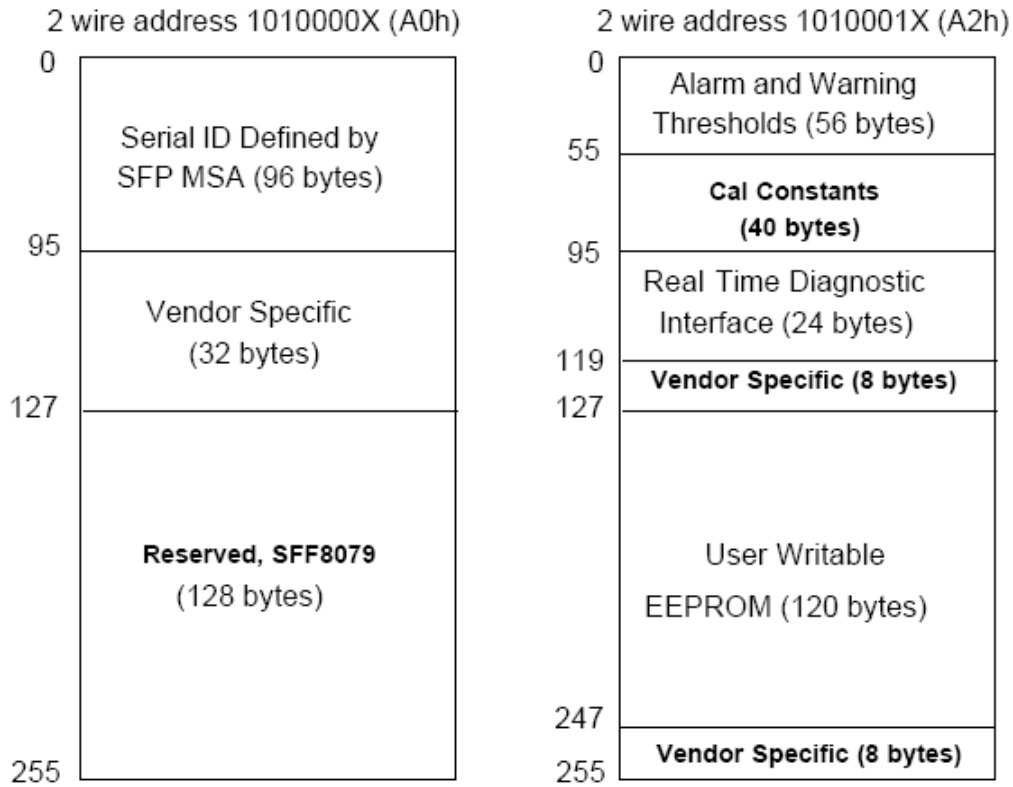

## Digital Diagnostic Monitoring Characteristics

Parameter	Symbol	Accuracy	Unit	Note
Transceiver Temperature	$T_{INT}$	$\pm 3$	$^{\circ}C$	
Transceiver Supply Voltage	$V_{INT}$	$\pm 3$	%	
TX Bias Current	$I_{BIAS}$	$\pm 10$	%	
TX Output Power	$P_{TX}$	$\pm 3$	dB	
RX Received Optical Power	$P_{RX}$	$\pm 3$	dB	

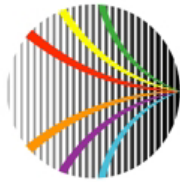

## Pin Description

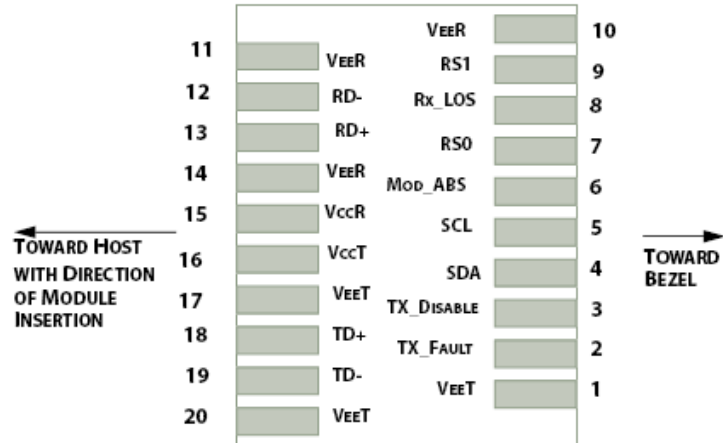

## Host PCB SFP+ pad assignment top view

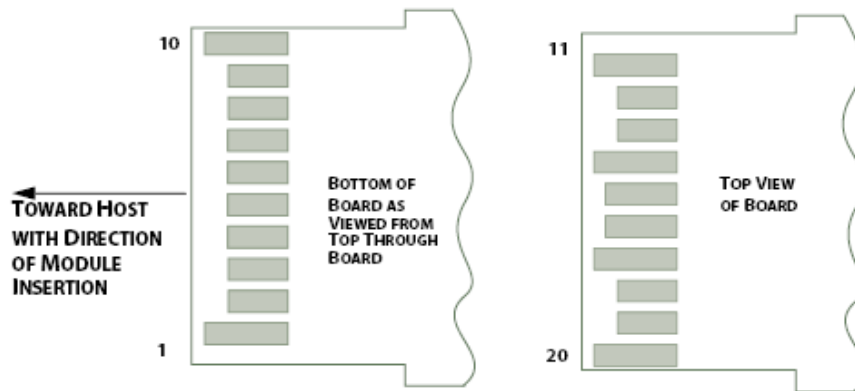

## SFP+ module contact assignment

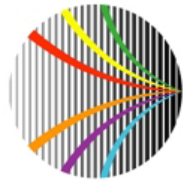

## SFP+ Module and Host Electrical contact definition

Contacts	Logic	Symbol	Power Sequence Order	Name / Description
1		VeeT	1st	Module Transmitter Ground
2	LVTTTL-O	TX_Fault	3rd	Module Transmitter Fault
3	LVTTTL-I	TX_Disable	3rd	Transmitter Disable; Turns off transmitter laser output
4	LVTTTL-I/O	SDA	3rd	2-wire Serial Interface Data Line (Same as MOD-DEF2 in the INF-8074i)
5	LVTTTL-I/O	SCL	3rd	2-wire Serial Interface Clock (Same as MOD-DEF1 in the INF-8074i)
6		Mod_ABS	3rd	Module Absent, connected to VeeT or VeeR in the module
7	LVTTTL-I	RS0	3rd	No connection required.
8	LVTTTL-O	RX_LOS	3rd	Receiver Loss of Signal Indication (In FC designated as RX_LOS and in Ethernet designated as Signal Detect Bar)
9	LVTTTL-I	RS1	3rd	No connection required.
10		VeeR	1st	Module Receiver Ground
11		VeeR	1st	Module Receiver Ground
12	CML-O	RD-	3rd	Receiver Inverted Data Output
13	CML-O	RD+	3rd	Receiver Non-Inverted Data Output
14		VeeR	1st	Module Receiver Ground
15		VccR	2nd	Module Receiver 3.3V Supply
16		VccT	2nd	Module Transmitter 3.3V Supply
17		VeeT	1st	Module Transmitter Ground
18	CML-I	TD+	3rd	Transmitter Non-Inverted Data Input
19	CML-I	TD-	3rd	Transmitter Inverted Data Input
20		VeeT	1st	Module Transmitter Ground



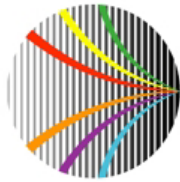

# AXCEN

PHOTONICS CORPORATION

## Mechanical Dimensions (Units in mm)

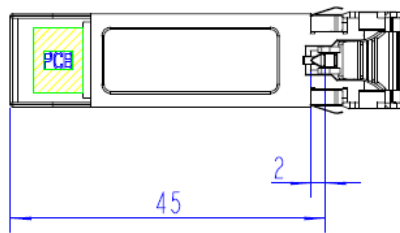
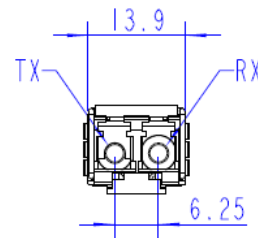
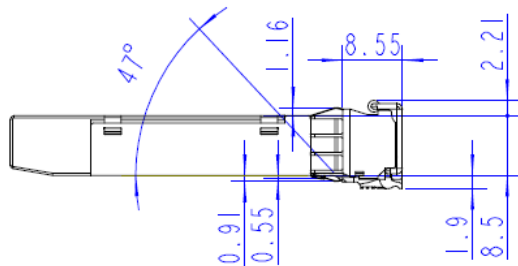
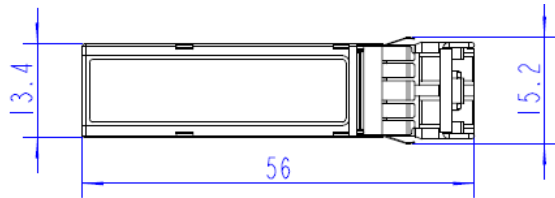

Unit : mm  
All dimensions are  $\pm 0.2$  mm unless otherwise specified.

## Ordering Information

Model No.	Wavelength	LD	I/O	LOS	Link	Temp.
AXXE-3386-0531	1310nm	DFB	AC/AC	TTL	10km	0~70°C
AXXE-3386-0533	1310nm	DFB	AC/AC	TTL	10km	-40~85°C