

# AXCEN

PHOTONICS CORPORATION

## **AXXE-5886 10Gbps Multi-mode 850nm VCSEL, SFP+ Transceiver**



### **Product Overview**

The AXXE-5886 is specifically designed for the high performance integrated duplex data link over multi-mode optical fiber. This transceiver module is compliant with the Small Form-factor Pluggable Plus (SFP+) Multi-Source Agreement (SFF-8432). An enhanced Digital Diagnostic Monitoring Interface has been incorporated into the Axcen SFP Transceiver. Real time monitors of temperature, supply voltage, laser bias current, laser average output power and received output power are provided, based on the SFF-8472.

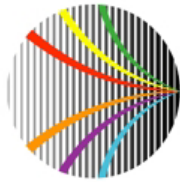
The AXXE-5886 SFP+ transceivers using a short wavelength (850nm) VCSEL enable data transmission up to 300m on a 50/125 $\mu$ m multi-mode optical fiber.

### **Features**

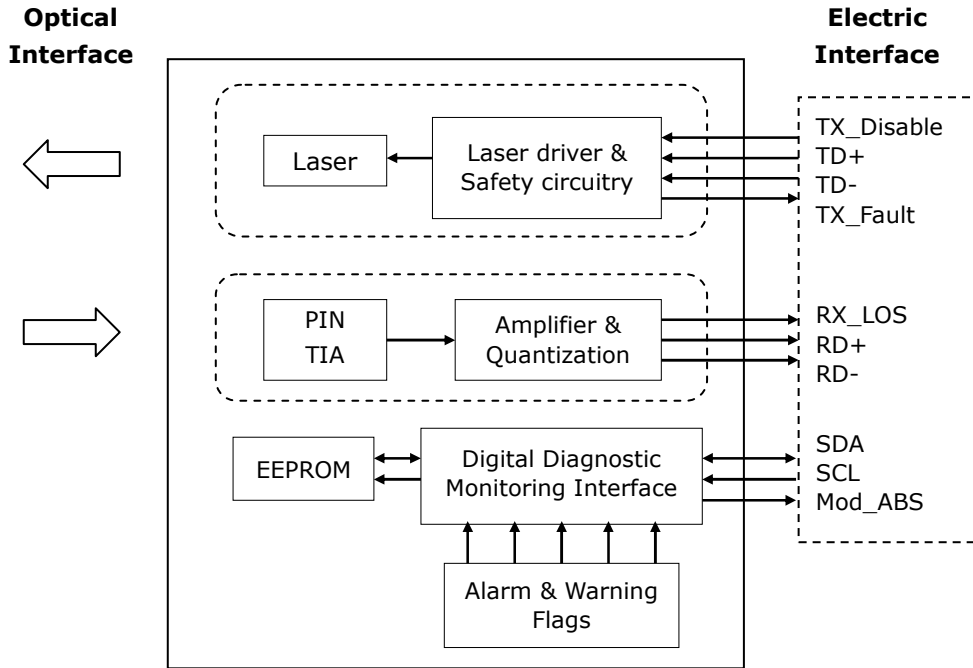
- **SFP+ Multi-Source Agreement**
- **LC duplex receptacle**
- **10Gbps IEEE 802.3ae 10GBASE-SR and 10GBASE-SW compliant**
- **SFF-8472 diagnostic monitoring interface for optical transceivers**
- **Alarms and warnings to indicate status of real time monitors**
- **Soft TX\_Disable control and monitoring implemented**
- **Soft TX\_FAULT monitoring implemented**
- **Soft RX\_LOS monitoring implemented**
- **Low power consumption**
- **Class 1 laser safety standard IEC 60825 compliant**

### **Applications**

- **8.5G Fibre Channel**
- **10 Gigabit Ethernet**



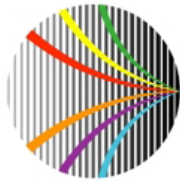
## Block diagram



The transceiver is fundamentally consisted by two parts: transmitter and receiver. The transmitter features a TTL logic level Disable signal and a Fault indicator. The receiver features a TTL logic Loss of Signal (RX\_LOS) detection. The serial ID interface defines a 256-byte memory map in EEPROM, accessible over a 2 wire, serial interface at the 8 bit address 1010000X (A0h). The Digital Diagnostic Monitoring Interface makes use of the 8 bit address 1010001X (A2h), so the originally defined serial ID memory map remains unchanged and is therefore backward compatible. The detailed signal descriptions are listed in the following sections.

## Absolute Maximum Ratings

Parameter	Symbol	Min.	Max.	Unit	Note
Storage Temperature	T <sub>s</sub>	-40	+85	°C	
Supply Voltage	V <sub>ccT</sub> V <sub>ccR</sub>	-0.5	+4.5	V	
Storage Relative Humidity	RH	5	95	%	
Optical Receiver Input Average Power			0	dBm	



## Recommended Operating Conditions

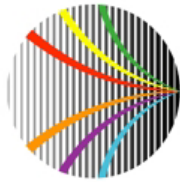
Parameter	Symbol	Min.	Typ.	Max.	Unit	Note
Case Operating Temperature	$T_C$	0		70	°C	Refer to ordering information
		-20		85		
		-40		85		
Supply Voltage	$V_{CC}$	3.14	3.3	3.46	V	
Supply Current	$I_{TX} + I_{RX}$		180	300	mA	
Transmitter Input Single Ended DC Voltage Tolerance		-0.3		4.0	V	
Receiver Output Single Ended DC Voltage Tolerance		-0.3		4.0	V	

## Transmitter Electro-Optical Interface

Parameter	Symbol	Min.	Typ.	Max.	Unit	Note
Transmitter Differential Input Voltage	TD +/-	180		700	mV(p-p)	
Data Dependent Input Jitter	DDJ			0.1	UI	
Data Input Total Jitter	DTJ			0.28	UI	
Tx_Fault - High	$V_{Fault\_H}$	2		$V_{CCT}$	V	
Tx_Fault - Low	$V_{Fault\_L}$	Vee		$V_{ee}+0.8$	V	
Tx_Disable - High	$V_{Disable\_H}$	2		$V_{CCT}$	V	
Tx_Disable - Low	$V_{Disable\_L}$	Vee		$V_{ee}+0.8$	V	
Average Launch Power	$P_O$	-7.3		-1	dBm	1
Launch Power in OMA	$P_{O\_OMA}$				dBm	1,2
Optical Extinction Ratio	$E_R$	3			dB	
Center Wavelength	$\lambda_C$	840	850	860	nm	
Spectral Width (RMS)	$\Delta\lambda$			0.45	nm	2
Relative Intensity Noise	$RIN_{12OMA}$			-128	dB/Hz	

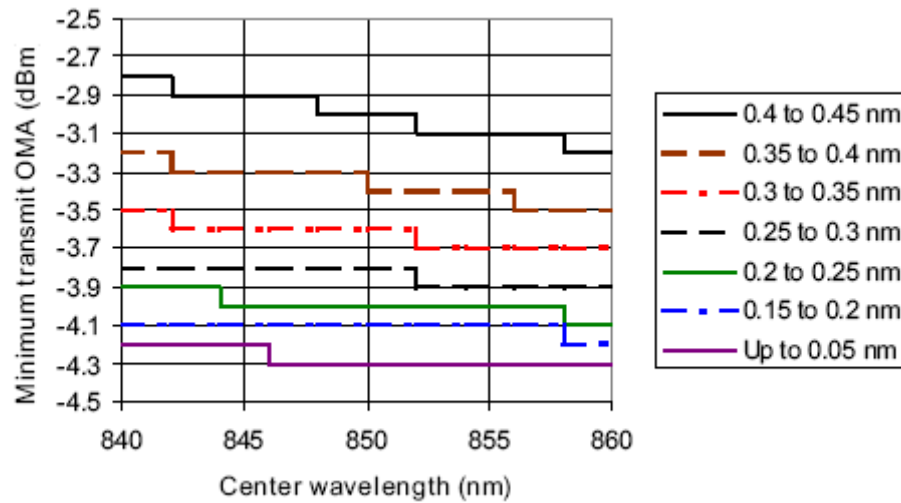
### Notes:

1. Coupling into a 50/125 $\mu$ m multi-mode fiber.
2. Trade-offs are available between spectral width, center wavelength and minimum optical modulation amplitude. See Table 1, Figure 1

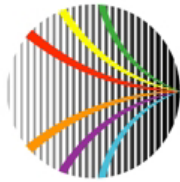


**Table 1 – Minimum 10GBASE-S optical modulation amplitude (dBm) as a function of center wavelength and spectral width**

Center Wavelength (nm)	RMS Spectral width (nm)								
	Up to 0.05	0.05 to 0.1	0.1 to 0.15	0.15 to 0.2	0.2 to 0.25	0.25 to 0.3	0.3 to 0.35	0.35 to 0.4	0.4 to 0.45
840 to 842	-4.2	-4.2	-4.1	-4.1	-3.9	-3.8	-3.5	-3.2	-2.8
842 to 844	-4.2	-4.2	-4.2	-4.1	-3.9	-3.8	-3.6	-3.3	-2.9
844 to 846	-4.2	-4.2	-4.2	-4.1	-4.0	-3.8	-3.6	-3.3	-2.9
846 to 848	-4.3	-4.2	-4.2	-4.1	-4.0	-3.8	-3.6	-3.3	-2.9
848 to 850	-4.3	-4.2	-4.2	-4.1	-4.0	-3.8	-3.6	-3.3	-3.0
850 to 852	-4.3	-4.2	-4.2	-4.1	-4.0	-3.8	-3.6	-3.4	-3.0
852 to 854	-4.3	-4.2	-4.2	-4.1	-4.0	-3.9	-3.7	-3.4	-3.1
854 to 856	-4.3	-4.3	-4.2	-4.1	-4.0	-3.9	-3.7	-3.4	-3.1
856 to 858	-4.3	-4.3	-4.2	-4.1	-4.0	-3.9	-3.7	-3.5	-3.1
858 to 860	-4.3	-4.3	-4.2	-4.2	-4.1	-3.9	-3.7	-3.5	-3.2



**Figure 1 –Triple tradeoff curve for 10GBASE-S (informative)**



## Receiver Electro-Optical Interface

Parameter	Symbol	Min.	Typ.	Max.	Unit	Note
Receiver Differential Output Voltage	RD +/-	300		1000	mVp-p	
Average Receiver Power	P <sub>IN</sub>	-9.9		-1	dBm	
Receiver Sensitivity in OMA	P <sub>IN_OMA</sub>			-11.1	dBm	1
Operating Center Wavelength	λ <sub>C</sub>	840		860	nm	
Receiver Reflectance	RL			-12	dB	
Receiver Loss of Signal De-Assert	P <sub>LOSD</sub>			-11	dBm	
Receiver Loss of Signal Assert	P <sub>LOSA</sub>	-30			dBm	
Receiver Loss of Signal Hysteresis	P <sub>LOSH</sub>	0.5			dB	
Receiver Loss of Signal - Low	V <sub>OL</sub>	-0.3		0.4	V	
Receiver Loss of Signal - High	V <sub>OH</sub>	2.0		V <sub>ccR</sub>	V	

### Notes:

1. With BER better than or equal to  $1 \times 10^{-12}$ , measured in the center of the eye opening with PRBS 2<sup>31</sup> -1

## Operating Range for Each Optical Fiber Type

Fiber type		Minimum modal bandwidth @850nm (MHz*km)	Operating range (meters)
62.5μm MMF		160	2 to 26
	OM1	200	2 to 33
50μm MMF		400	2 to 66
	OM2	500	2 to 82
	OM3	2000	2 to 300

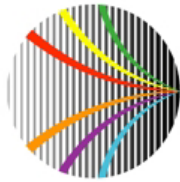


## Two-Wire Interface

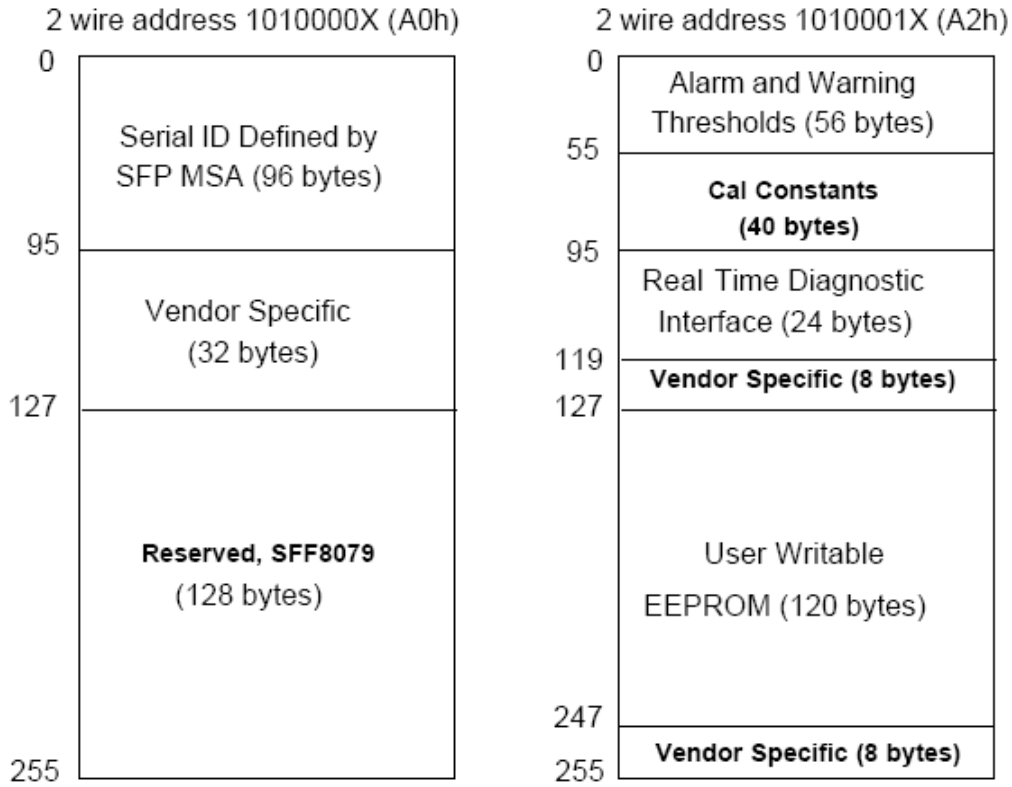
Parameter	Symbol	Min.	Max.	Unit	Note
Host 2-wire Vcc	$V_{CC\_HTWI}$	3.14	3.46		1
SCL and SDA	$V_{OL}$	0.0	0.40	V	2
	$V_{OH}$	$V_{CC\_HTWI}-0.5$	$V_{CC\_HTWI}+0.3$		
SCL and SDA	$V_{IL}$	-0.3	$V_{CC}T*0.3$	V	
	$V_{IH}$	$V_{CC}T*0.7$	$V_{CC}T + 0.5$		
Input current on the SCL and SDA contacts	$I_I$	-10	10	$\mu A$	
Capacitance on SCL and SDA Contacts	$C_i$		14	pF	3
Total bus capacitance for SCL and SDA	$C_b$		100	pF	4
			290		5
Clock Frequency	$f_{SCL}$		400	kHz	
Two-Wire Interface Ready	$t_{serial}$		300	ms	6

### Notes:

1. The Host 2-wire Vcc is the voltage used for resistive pull ups for the 2 wire interface.
2. Rp2w pulled toVcc\_Host\_2w. Rp2w is the pull up resistor. Active bus termination may be used by the host in place of a pullup resistor. Pull ups can be connected to any one of several power supplies, however the host board design shall ensure that no module contact has voltage exceeding module  $V_{CC}T/R + 0.5$  V nor requires the module to sink more than 3.0 mA current.
3. Ci is the capacitance looking into the module SCL and SDA contacts
4. At 400 kHz, 3.0 k $\Omega$  Rp2w, max; At 100 kHz, 8.0 k $\Omega$  Rp2w, max
5. At 400 kHz, 1.1 k $\Omega$  Rp2w, max; At 100 kHz, 2.75 k $\Omega$  Rp2w, max
6. Time from power on until module is ready for data transmission over the two-wire interface.

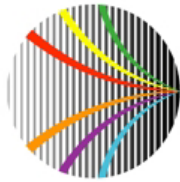


## Digital Diagnostic Memory Map

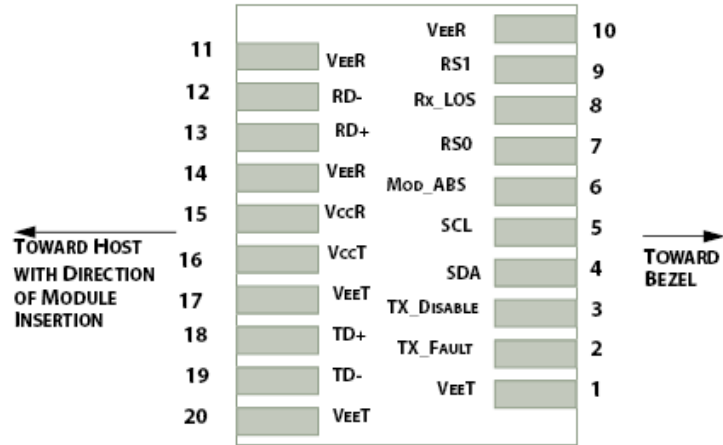


## Digital Diagnostic Monitoring Characteristics

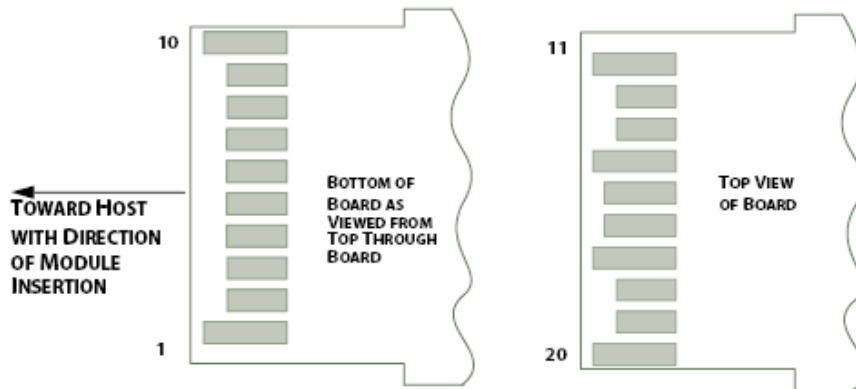
Parameter	Symbol	Accuracy	Unit	Note
Transceiver Temperature	$T_{INT}$	$\pm 3$	$^{\circ}C$	
Transceiver Supply Voltage	$V_{INT}$	$\pm 3$	%	
TX Bias Current	$I_{BIAS}$	$\pm 10$	%	
TX Output Power	$P_{TX}$	$\pm 3$	dB	
RX Received Optical Power	$P_{RX}$	$\pm 3$	dB	



## Pin Description

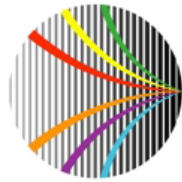


## Host PCB SFP+ pad assignment top view



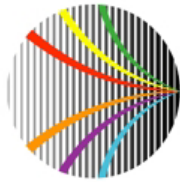
## SFP+ module contact assignment





## SFP+ Module and Host Electrical contact definition

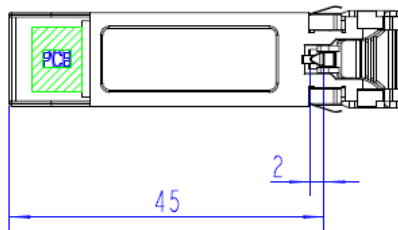
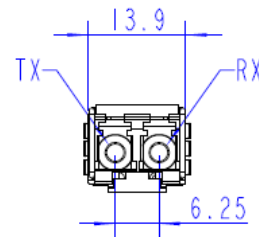
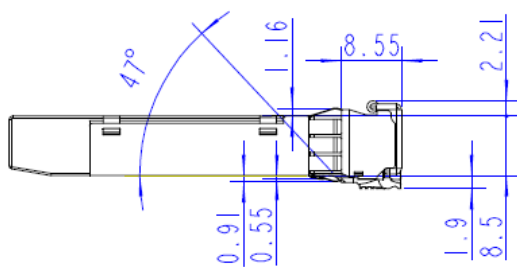
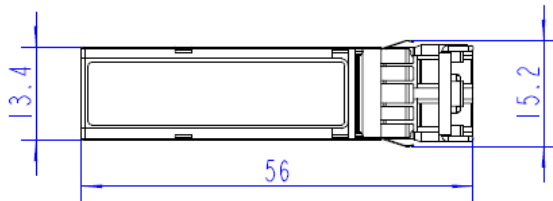
Contacts	Logic	Symbol	Power Sequence Order	Name / Description
1		VeeT	1st	Module Transmitter Ground
2	LVTTTL-O	TX_Fault	3rd	Module Transmitter Fault
3	LVTTTL-I	TX_Disable	3rd	Transmitter Disable; Turns off transmitter laser output
4	LVTTTL-I/O	SDA	3rd	2-wire Serial Interface Data Line (Same as MOD-DEF2 in the INF-8074i)
5	LVTTTL-I/O	SCL	3rd	2-wire Serial Interface Clock (Same as MOD-DEF1 in the INF-8074i)
6		Mod_ABS	3rd	Module Absent, connected to VeeT or VeeR in the module
7	LVTTTL-I	RS0	3rd	No connection required.
8	LVTTTL-O	RX_LOS	3rd	Receiver Loss of Signal Indication (In FC designated as Rx_LOS and in Ethernet designated as Signal Detect Bar)
9	LVTTTL-I	RS1	3rd	No connection required.
10		VeeR	1st	Module Receiver Ground
11		VeeR	1st	Module Receiver Ground
12	CML-O	RD-	3rd	Receiver Inverted Data Output
13	CML-O	RD+	3rd	Receiver Non-Inverted Data Output
14		VeeR	1st	Module Receiver Ground
15		VccR	2nd	Module Receiver 3.3V Supply
16		VccT	2nd	Module Transmitter 3.3V Supply
17		VeeT	1st	Module Transmitter Ground
18	CML-I	TD+	3rd	Transmitter Non-Inverted Data Input
19	CML-I	TD-	3rd	Transmitter Inverted Data Input
20		VeeT	1st	Module Transmitter Ground



# AXCEN

PHOTONICS CORPORATION

## Mechanical Dimensions (Units in mm)



Unit : mm  
 All dimensions are  $\pm 0.2$  mm unless otherwise specified.

## Ordering Information

Model No.	Wavelength	LD	I/O	LOS	Link	Temp.
AXXE-5886-05B1	850nm	VCSEL	AC/AC	TTL	300m	0~70°C
AXXE-5886-05B2	850nm	VCSEL	AC/AC	TTL	300m	-20~85°C
AXXE-5886-05B3	850nm	VCSEL	AC/AC	TTL	300m	-40~85°C